

Molteni & C

GREGOR — VINCENT VAN DUYSSEN 2019

1—
9



Vincent van Duysen continues his research into the world of contemporary living by designing this Gregor modular system for Molteni&C. It includes various straight, corner or peninsular units that can be mixed and matched together to give multiple combinations for a living space destined for conversation, reading and entertainment, with all the media devices readily available. The multiple features distinguishing this range underline the overall lightness of the design. The steel base, in a new zinc finish, supported by small feet that recall VVD's most recent furniture designs, such as the Quinten sideboards or the Jan small tables, is covered in leather, as are the winged armrests suitable for supporting soft cushions while at the same time acting as a useful surface.



This symbol shows that the product has removable upholstery. Only qualified personnel can remove the upholstery of some of our products. If this information is pertinent, it will be included in the warnings section.



This symbol shows that the product is available on request in a fire resistant version that complies with the standards BS 5852 and TB 117-2013. The buyer is responsible for checking to make sure that the product is suitable and compliant with the requirements for the designated use and the current applicable laws and standards for the destination and use of the product.

DATASHEET

REGISTERED
DESIGN

IX.2022

moltenigroup.com

Dimensions in centimeters and inches. The right to discontinue and make changes is reserved. This information is based on the latest product information available at the time of printing.

FINISHES

BASE FINISHES

painted zinc
painted pewter colour

TECHNICAL INFORMATION

BASE

Painted electro-welded steel with plastic floor slides.

UNDERSEAT STRUCTURE

Shaped plywood panel with elastic straps and high density polyurethane top filler.
Cover in polyurethane bonded with polyester fibre.

INTERNAL STRUCTURE OF PADDED PARTS

Frame made of solid spruce (Picea abies) and particle board panels.

STRUCTURAL PADDING OF PADDED PARTS

High performance variable density polyurethane foam. Cover in bonded velveteen.

SEAT CUSHION

Insert in shaped polyurethane and sterilized feathers. Case in 100% cotton.

BACK CUSHIONS

Solotex. Case in 100% cotton.

WING-SHAPED ARMREST

Metal load-bearing frame with cold-moulded polyurethane foam padding and cover in cotton/polyester fibre.

HEADREST FIXED

Shaped plywood panel. Cover in polyurethane bonded with polyester fibre.

HEADREST BOLSTER CUSHION

Polyurethane foam with high bearing capacity. Cover in bonded velveteen.

REMOVABLE OUTER COVER

(See enclosed sheet, specific for the cover in question).



AVAILABLE IN FIRE-RESISTANT
VERSION TB117 AND BS5852

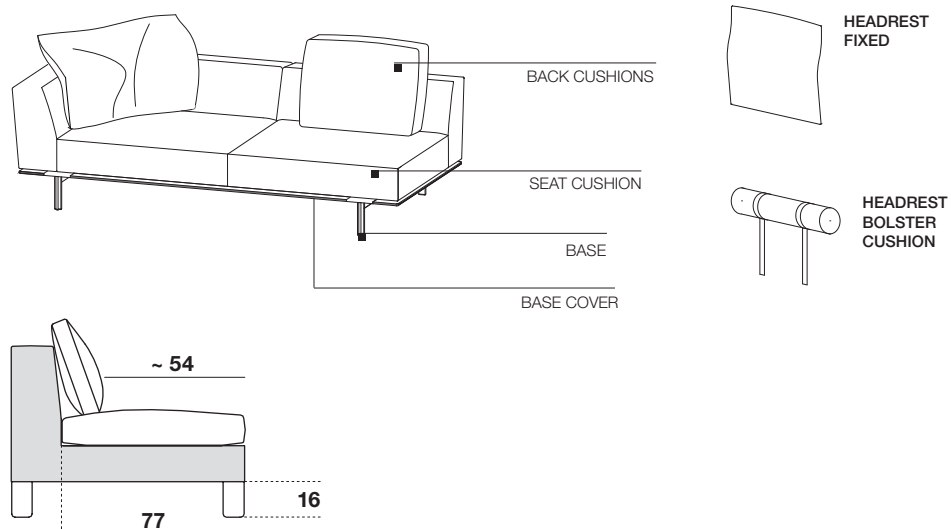

DATASHEET

REGISTERED
DESIGN

IX.2022

Seat depth for structure only, 77 cm

Seat depth with backrest cushion, ~ 54 cm

Feet height 16 cm (from ground to under seat)

NOTES

- List codes with **final A:**
All elements covers in fabric of the same category and colour.
All elements covers in leather of the same category and colour.
- List codes with **final B:**
Base and armrest covers in leather / structure + cushion covers in fabric.
- The headrest bolster cushion PGR1B has a fabric bolster cushion with leather retaining straps.

When ordering

Specify the type of backrest.

Suggested configurations

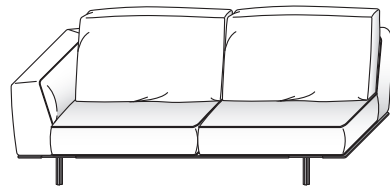
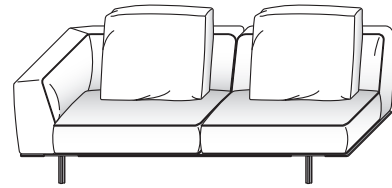
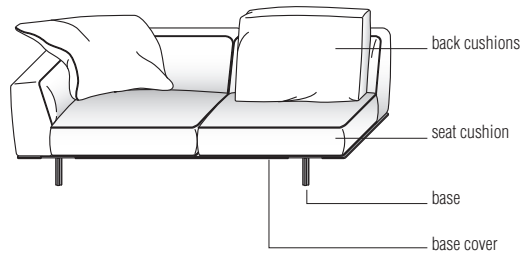

Examples of compositions

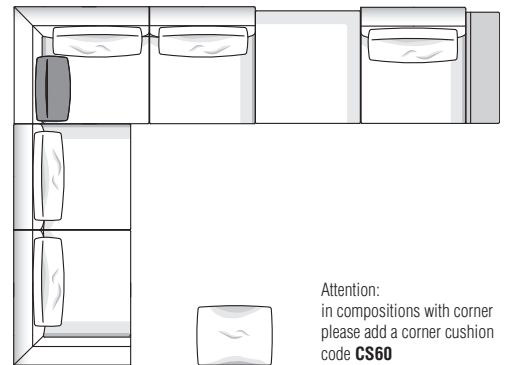

Attention:
in compositions with corner
please add a corner cushion
code **CS60**

Measurement details

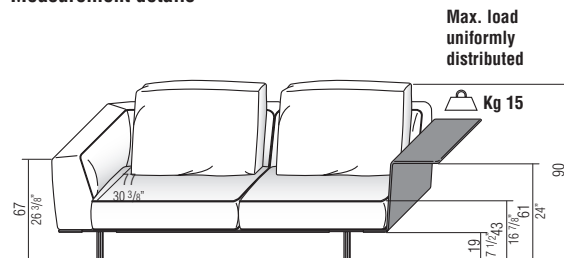

Headrest fixed



Examples of use of the headrest

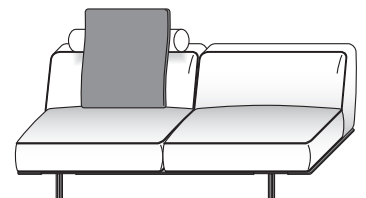
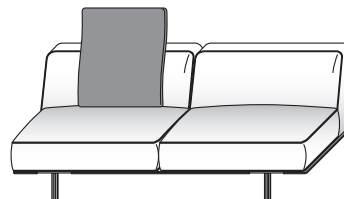

Headrest bolster cushion

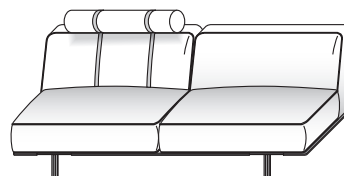
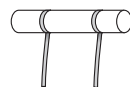

DATASHEET

REGISTERED
DESIGN

IX.2022

DIMENSIONS

sofa
DV283A DV283B

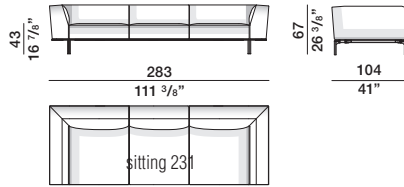

back cushion
CS65

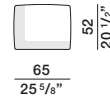

back cushion
CS77

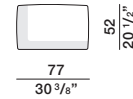

ornamental cushion
PCU90/75

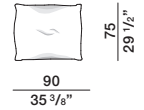

sofa with armrests
DB291A DB291B

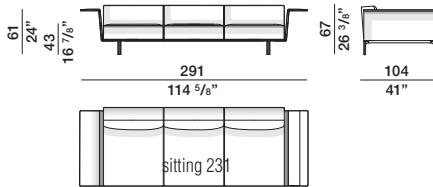

back cushion
CS65

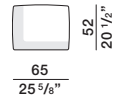

back cushion
CS77

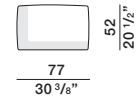

ornamental cushion
PCU90/75

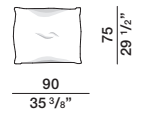

sofa
DV262A DV262B

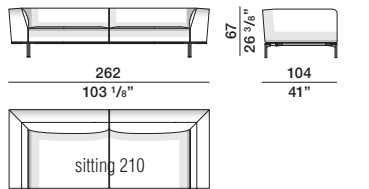

back cushion
CS65

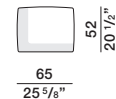

back cushion
CS95

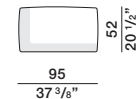

ornamental cushion
PCU90/75

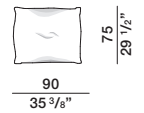

sofa with armrests
DB270A DB270B

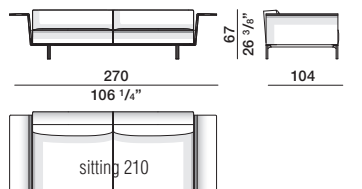

back cushion
CS65

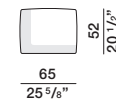

back cushion
CS95

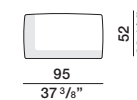

ornamental cushion
PCU90/75

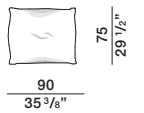

sofa
DV242A DV242B

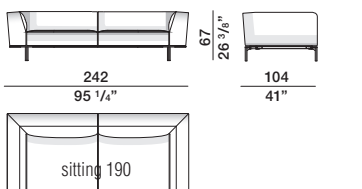

back cushion
CS77

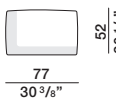

back cushion
CS95

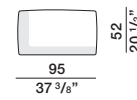

ornamental cushion
PCU90/75

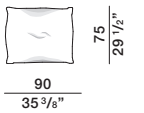

DATASHEET

REGISTERED
DESIGN

IX.2022

DIMENSIONS

sofa with armrest

DB246A dx-sx DB246B dx-sx

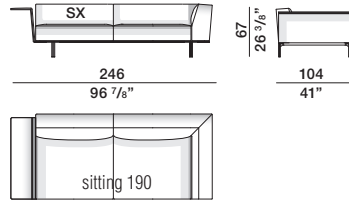

back cushion

CS77

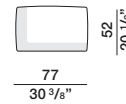

back cushion

CS95

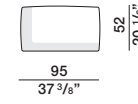

ornamental cushion

PCU90/75

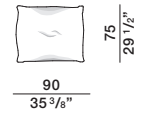

sofa with armrests

DB250A DB250B

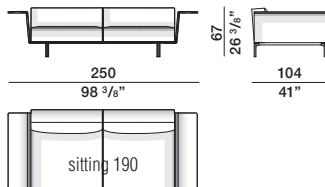

back cushion

CS77

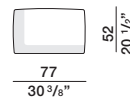

back cushion

CS95

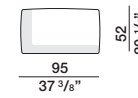

ornamental cushion

PCU90/75

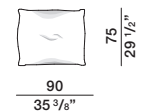

sofa

DV206A DV206B

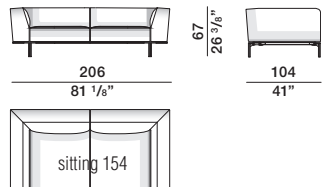

back cushion

CS65

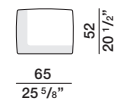

back cushion

CS77

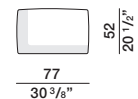

ornamental cushion

PCU90/75

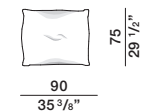

sofa with armrest

DB210A dx-sx DB210B dx-sx

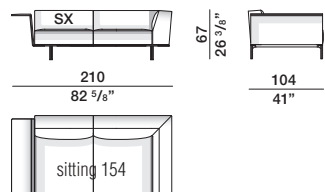

back cushion

CS65

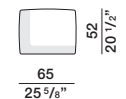

back cushion

CS77

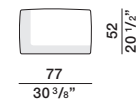

ornamental cushion

PCU90/75

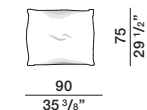

sofa with armrests

DB214A DB214B

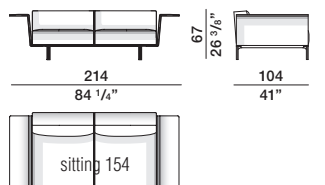

back cushion

CS65

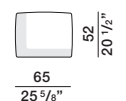

back cushion

CS77

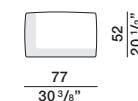

ornamental cushion

PCU90/75

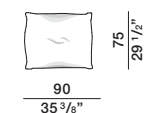

DATASHEET

REGISTERED
DESIGN

IX.2022

DIMENSIONS

end element

TR216A dx-sx TR216B dx-sx

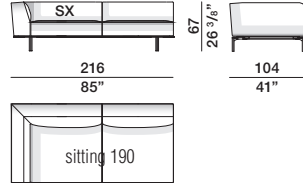

end element

TR180A dx-sx TR180B dx-sx

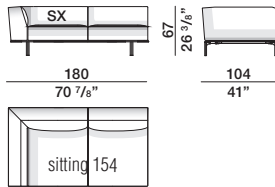

end element with armrest

TB220A dx-sx TB220B dx-sx

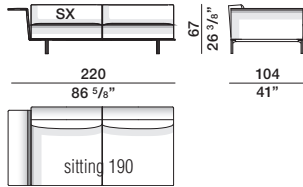

end element with armrest

TB184A dx-sx TB184B dx-sx

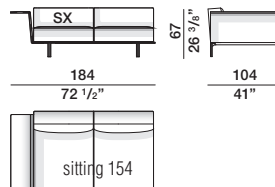

central element

CN191A CN191B

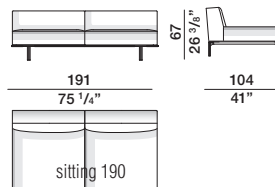

back cushion

CS77

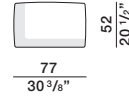

back cushion

CS65

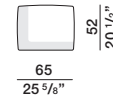

back cushion

CS77

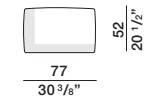

back cushion

CS65

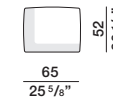

back cushion

CS77

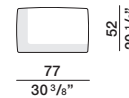

back cushion

CS95

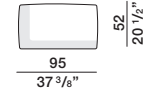

back cushion

CS77

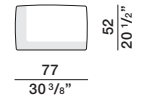

back cushion

CS95

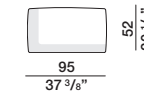

back cushion

CS77

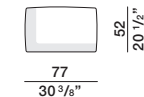

back cushion

CS95

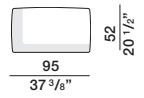

ornamental cushion

PCU90/75

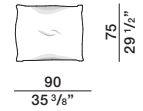

ornamental cushion

PCU90/75

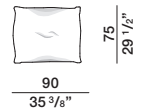

ornamental cushion

PCU90/75

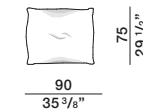

ornamental cushion

PCU90/75

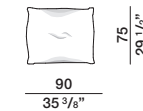

ornamental cushion

PCU90/75

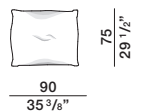

DATASHEET

REGISTERED
DESIGN

IX.2022

DIMENSIONS

central element

CN155A CN155B

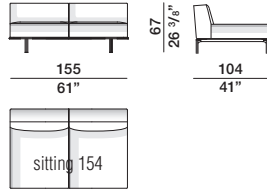

back cushion

CS65

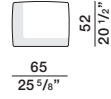

back cushion

CS77

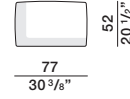

ornamental cushion

PCU90/75

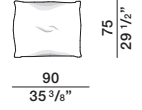

island with armrest

IB220A dx-sx IB220B dx-sx

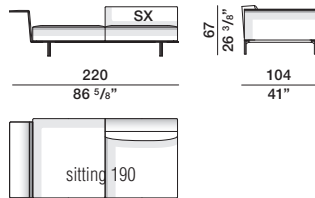

back cushion

CS77

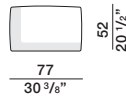

back cushion

CS95

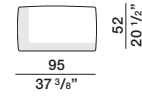

ornamental cushion

PCU90/75

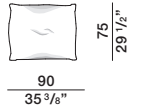

island with armrest

IB184A dx-sx IB184B dx-sx

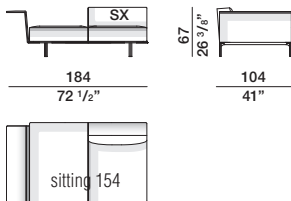

back cushion

CS65

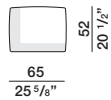

back cushion

CS77

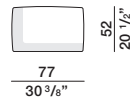

ornamental cushion

PCU90/75

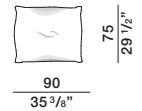

chaise longue

CL216A dx-sx CL216B dx-sx

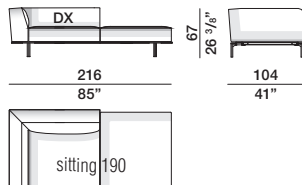

back cushion

CS77

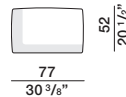

back cushion

CS95

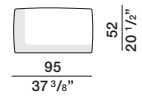

ornamental cushion

PCU90/75

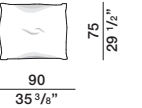

DATASHEET

REGISTERED
DESIGN

IX.2022

DIMENSIONS

end element with armrest

TC220A dx-sx TC220B dx-sx

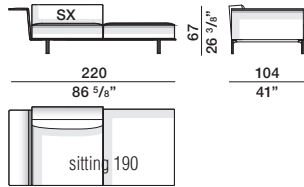

chaise longue

CL180A dx-sx CL180B dx-sx

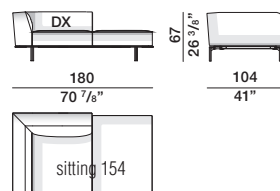

end element with armrest

TC184A dx-sx TC184B dx-sx

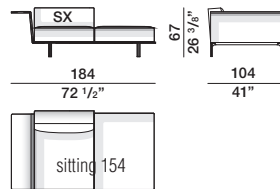

island

IS191A dx-sx IS191B dx-sx

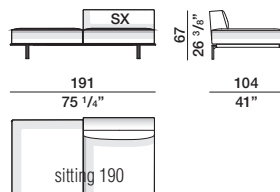

island

IS155A dx-sx IS155B dx-sx

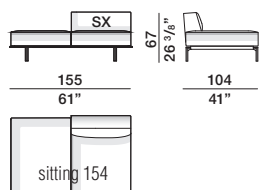

back cushion

CS77

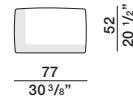

back cushion

CS95

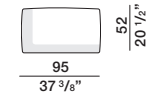

ornamental cushion

PCU90/75

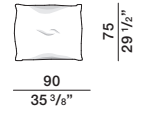

back cushion

CS65

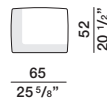

back cushion

CS77

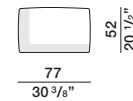

ornamental cushion

PCU90/75

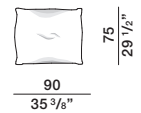

back cushion

CS65

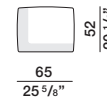

back cushion

CS77

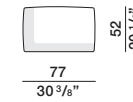

ornamental cushion

PCU90/75

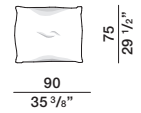

back cushion

CS77

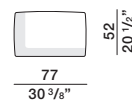

back cushion

CS95

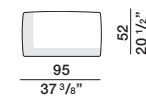

ornamental cushion

PCU90/75

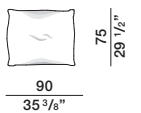

back cushion

CS65

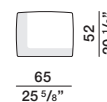

back cushion

CS77

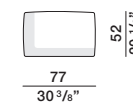

ornamental cushion

PCU90/75

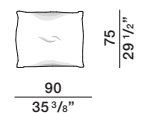

DATASHEET

REGISTERED
DESIGN

IX.2022

DIMENSIONS

pouf

PF099A

PF099B

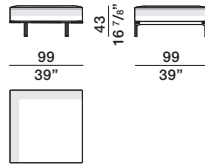

corner cushion

CS60



headrest fixed

PGT1

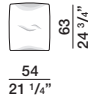

headrest bolster cushion

bolster cushion Ø 12-4 3/4"

PGR1A

PGR1B



ornamental cushions

single cushion

CU/50



pair of additional cushions

CCQ/50



additional cushion

CU/60



additional cushion

CU/50/40



additional cushion

CU40/40



code	gross weight kg.	volume mc.	packages	code	gross weight kg.	volume mc.	packages
DV283A - DV283B	159	2,789	1	TB184A - TB184B	95	1,65	1
DB291A - DB291B	140	2,4	1	CN191A - CN191B	105	1,8	1
DV262A - DV262B	135	2,4	1	CN155A - CN155B	79	1,403	1
DB270A - DB270B	135	2,3	1	IB220A - IB220B	100	1,9	1
DV242A - DV242B	122	2,274	1	IB184A - IB184B	90	1,6	1
DB246A - DB246B	130	2,15	1	CL216A - CL216B	108	1,95	1
DB250A - DB250B	120	2,2	1	TC220A - TC220B	100	1,9	1
DV206A - DV206B	120	1,83	1	CL180A - CL180B	95	1,63	1
DB210A - DB210B	115	1,88	1	TC184A - TC184B	90	1,65	1
DB214A - DB214B	110	1,85	1	IS191A - IS191B	85	1,6	1
TR216A - TR216B	106	2,044	1	IS155A - IS155B	75	1,35	1
TR180A - TR180B	100	1,655	1	PF099A - PF099B	45	0,66	1
TB220A - TB220B	110	1,9	1				

DATASHEET

REGISTERED
DESIGN

IX.2022